

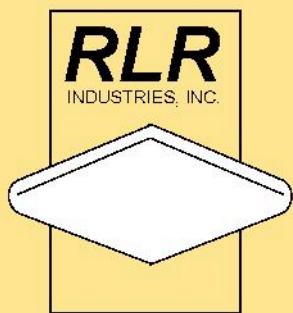

END CAP BATH BARS

VANITY DIFFUSERS

The End Cap Bath Bar series of diffuser assemblies allow the lighting designer and manufacturer to produce a cost effective, yet elegantly styled luminaire. The diffuser assembly consists of a solid white, clear fluted, or white fluted profile mated to a choice of end cap sizes and colors. By utilizing our spring clips with a standard 1-lite strip fixture, a low cost luminaire with a high perceived value can be achieved. The spring clips, when fastened to the strip fixture, creates a pressure fit mounting method, allowing the completed luminaire to be suitable for either vertical or horizontal wall mounts. In addition, the diffuser assemblies are ADA compliant. A range of colors are available from basic opaque white to a family of marble effects. RLR has developed colors which can emulate effects of translucent alabaster or marble grains, or a variety of opaque faux marble finishes. RLR can also develop a custom end cap color, shape, or custom profile for proprietary applications if requested by the manufacturer. Custom diffuser lengths are available, please contact the factory for details.



575 DISCOVERY PLACE
MABLETON, GEORGIA 30126

Phone:(770) 948-6069

Fax:(770) 948-1389

EXPLODED ASSEMBLY VIEW

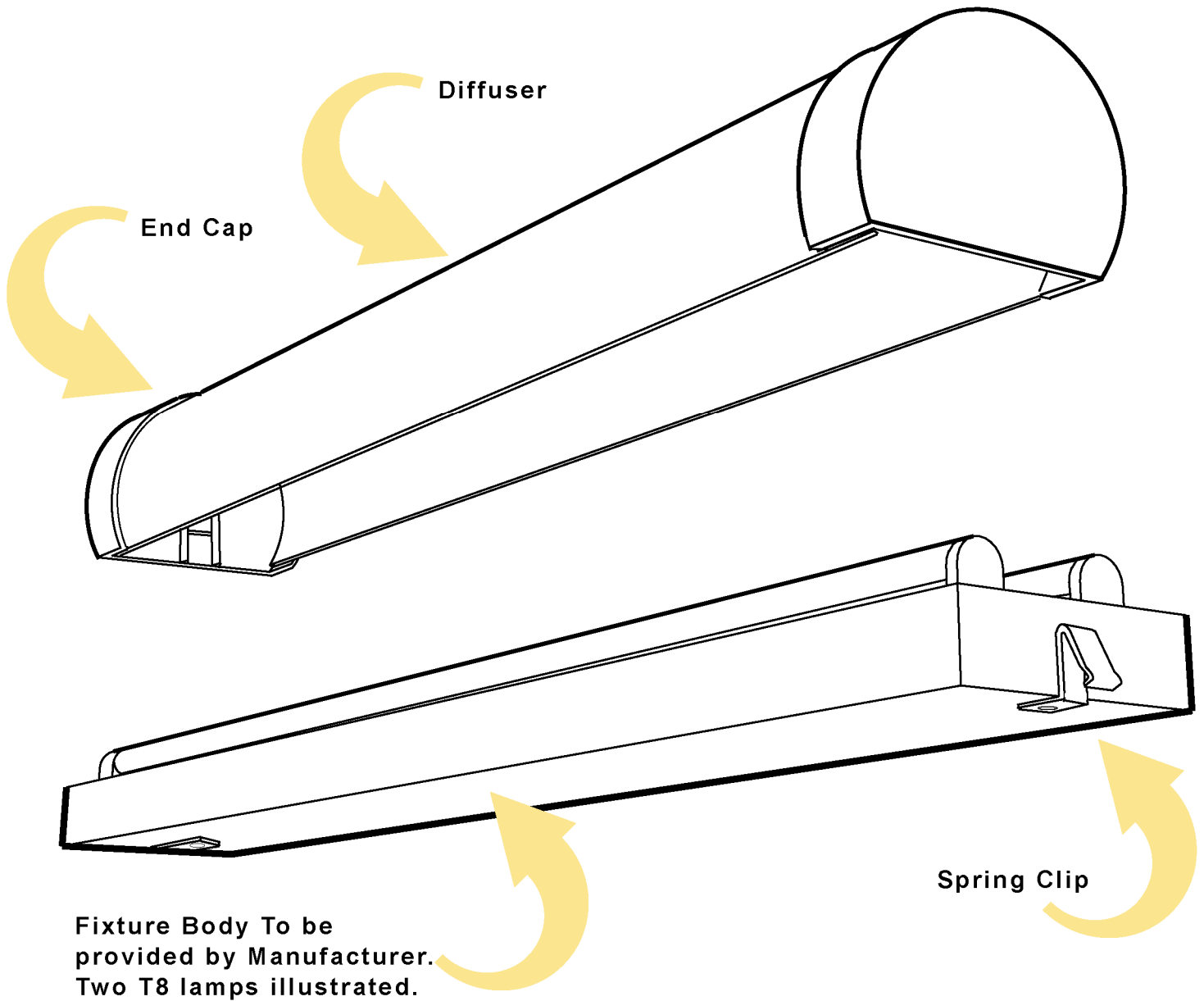

DIMENSIONS

Standard End Cap (1 1/2" wide) - EC

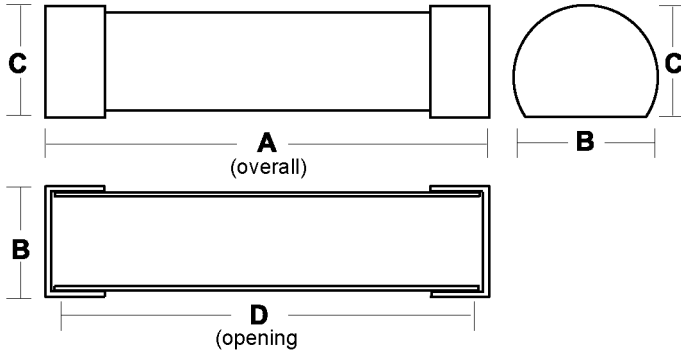

Series	Length	A	B	C	D
EC	2	25 1/2	4 3/4	4	25
EC	3	37 1/2	4 3/4	4	37
EC	4	49 1/2	4 3/4	4	49

Narrow End Cap (1/2" wide) - ECN

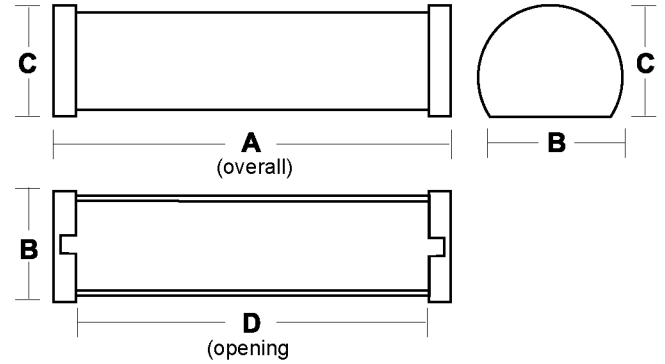

Series	Length	A	B	C	D
ECN	2	25 1/2	4 3/4	4	24 1/8
ECN	3	37 1/2	4 3/4	4	36 1/8
ECN	4	49 1/2	4 3/4	4	48 1/8

ORDERING INFORMATION

All RLR End Cap Bath Bars are individually packed. Bulk packaging provided upon request.

Each RLR End Cap Bath Bar requires 2 pcs. of ENDCAPCLIP spring clip for fastening to the strip fixture. The ENDCAPCLIP product is bulk packed and must be ordered separately.

Wide caps can be sandblasted upon request (Sandblast option).

Standard End Cap (1 1/2" wide)

Example: 2' Ivory Marble with White Ribbed Diffuser and Chrome Trim

EC	2	IV	WR	C	
Series	Length	Color	Diffuser	Trim	Sandblast

Series	Length	Color	Diffuser	Trim	Sandblast Option
EC	2-(2 foot) 3-(3 foot) 4-(4 foot)	IV-Ivory Marble BM-Black Marble VG-Verde Green PM-Peach Marble SW-Solid White AL-Alabaster TO-Tortoise WM-White Marble BW-Bone White BG-Black Gravel	WR-White Ribbed CR-Clear Ribbed (none)-White Smooth	C-Chrome B-Brass (None)-No trim	SB-Sandblast (None)-Standard Finish

Narrow End Cap (1/2" wide)

Example: 2' Narrow Solid White with Clear Ribbed Diffuser

ECN	2	SW	CR
Series	Length	Color	Diffuser

Series	Length	Color	Diffuser
ECN	2-(2 foot) 3-(3 foot) 4-(4 foot)	IV-Ivory Marble BM-Black Marble VG-Verde Green PM-Peach Marble SW-Solid White AL-Alabaster TO-Tortoise WM-White Marble BW-Bone White BG-Black Gravel SV-Silver	WR-White Ribbed CR-Clear Ribbed (none)-White Smooth

End Cap Clip - Spring Clip

Example: End Cap Clip

ENDCAPCLIP
P/N

Series	PACK
ENDCAPCLIP	Bulk

END CAP COLOR SELECTION GUIDE

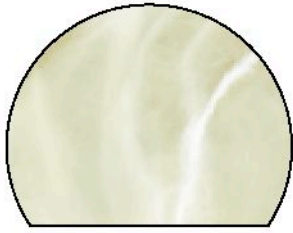

IV-Ivory Marble

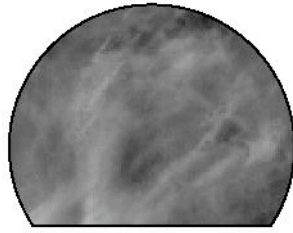

BM-Black Marble

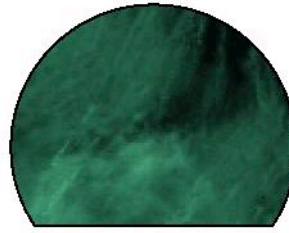

VG-Verde Green

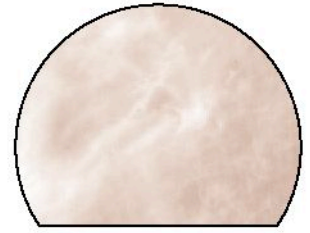

PM-Peach Marble

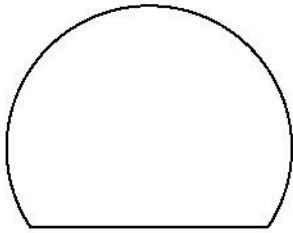

SW-Solid White



AL-Alabaster

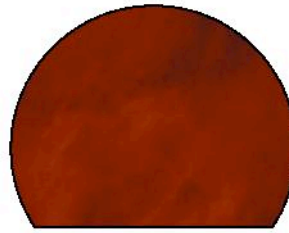

TO-Tortoise

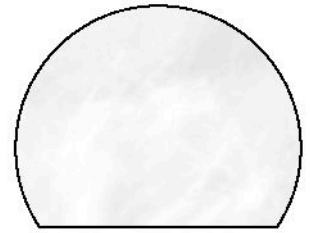

WM-White Marble

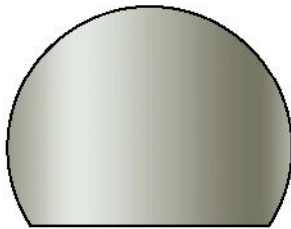

SV-Silver
(narrow only)

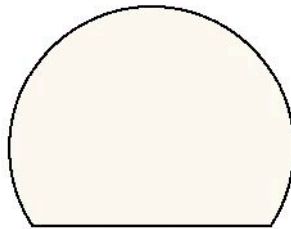

BW-Bone White

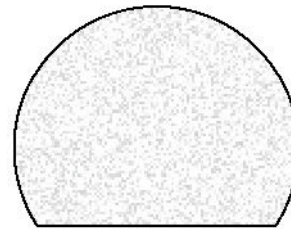

BG -Black Gravel

RLR STANDARD END CAP TRIM OPTIONS

RLR Standard End Caps are available with Chrome or Brass Accent Trim Strips Applied



Example of Ivory with Chrome Strips



Example of Ivory with Brass Strips